

NEO

User's Manual



Model: **VAP 1**

SAFETY INSTRUCTIONS

1. Please read these safety instructions carefully.
2. Keep this User's Manual for future reference.
3. Unplug the equipment from the AC power supply before cleaning.
4. Do not use liquid or aerosol cleaners. Do not allow the unit to get wet.
5. Keep this equipment away from humidity.
6. Lay this equipment on a reliable flat surface before setting it up. If you don't do so, the equipment can fall down and get damaged.
7. Place the power cord so that it is not likely to be walked on or pinched by having objects placed on it.
8. Always take into account all warnings and equipment precautions.
9. In order to avoid electric overload, unplug the equipment from the wall outlet if it is not going to be used for several days. Never pour liquid into the grilles, it could cause fire or electric shock.
10. Do never open the equipment. For safety reasons, the equipment should only be opened by qualified staff.
11. Pay attention to polarity when using a DC power supply. Reverse polarity may damage the equipment or the power supply.
12. If any of the following situation arises, get the equipment checked by a service technician:
 - a) The cable or power plug is damaged.
 - b) Liquid was poured into the equipment.
 - c) The equipment has been exposed to moisture.
 - d) The equipment has not been working well or you cannot get it work according to this manual.
 - e) The equipment have fallen down and it is damaged.
 - f) The equipment has obvious sign of breakage
13. Disconnect the audio inputs and outputs while making connections. Make sure to use the proper cables to make the connections.

Table of Contents

1 INTRODUCTION.....	1
2 DESCRIPTION.....	1
2.1 INDICATORS.....	2
2.1.1 GENERAL CONDITION INDICATORS.....	2
2.1.2 SUPERVISED FUNCTIONS INDICATORS.....	2
2.1.3 EMERGENCY ALERT SOURCE INDICATORS.....	3
2.1.4 SELECTION INDICATORS.....	3
2.2 CONTROLS.....	3
2.2.1 EMG.....	3
2.2.2 RESET.....	4
2.2.3 ACK.....	4
2.2.4 EVAC MSG.....	4
2.2.5 ALERT MSG.....	4
2.2.6 TEST.....	4
2.2.7 TALK.....	4
2.2.8 ACSI BUS TERMINATOR.....	5
2.2.9 ACSI POWER SUPPLY SELECTOR.....	5
2.2.10 KEYBOARD IDENTIFICATOR.....	5
2.3 INPUTS AND OUTPUTS.....	6
2.3.1 PA SYSTEM INPUT/OUTPUT.....	7
2.3.2 EXTERNAL POWER SUPPLY/UPDATE INPUT.....	7
2.3.3 PORTS FOR EXPANSION KEYBOARDS.....	8
3 OPERATION DESCRIPTION:.....	8
3.1 TURNING ON.....	8
3.2 EMERGENCY.....	8
3.2.1 ACTIVATING EMERGENCY CONDITION.....	9
3.2.2 ISSUING VOICE WARNING.....	9
3.2.3 STOPPING VOICE WARNING.....	9
3.2.4 DEACTIVATING EMERGENCY CONDITIONS.....	9
3.2.5 EVENT LAUNCHING.....	9
3.3 FAULT.....	9
3.3.1 MUTING FAULT CONDITION.....	10
3.3.2 RESETTING FAULT CONDITION.....	10
3.4 TESTING.....	10
4 CONNECTION AND SETTING UP.....	10
4.1 SUPPLY.....	10
4.2 CONNECTION TO THE SYSTEM OF VOICE EVACUATION (ACSI BUS).....	10
4.3 ADDRESSING AND PRIORITY CONFIGURATION.....	10
4.4 VAP 1 CONFIGURATION.....	11
4.4.1 CONFIGURATION. WARNING TONE.....	11
4.4.2 CONFIGURATION. OUTPUT VOLUME.....	12
4.5 EXPANSION KEYBOARDS CONNECTION.....	12
5 UPDATE.....	13
6 INSTALLATION.....	15
6.1 INSTALLATION FOR THE 19" RACK.....	15
6.2 WALL INSTALLATION.....	16
7 FAULT RESOLUTIONS.....	17
7.1 THERE IS NO LINK WITH THE SYSTEM.....	18
7.2 "REMOTE CTRL" AND "EMG" INDICATORS BLINK SIMULTANEOUSLY.....	18
7.3 NO INDICATOR LIGHTS UP.....	18
7.4 THE VOICE WARNING SOUNDS LOUD/LOW.....	18
7.5 MICROPHONE FAULT.....	19
7.6 EXPANSION KEYBOARDS DO NOT ADDRESS THE ZONES.....	19
7.7 THE EXPANSION KEYBOARD DOES NOT LIGHT UP.....	19
8 MAINTENANCE INSTRUCTIONS.....	19
9 TECHNICAL FEATURES.....	21

1 INTRODUCTION

The Public Address and Voice Evacuation NEO System complies with all requirements in accordance with EN54-16, ensuring a safe and controlled emergency evacuation. Its high features, versatility and audio quality make it a powerful and affordable music and voice distribution system for all types of installations.

The Voice Alarm Panel is designed to provide the NEO system with controls for the evacuation system in different locations. The expansion keyboards available allow the adaptation to the particularities of each system.

2 DESCRIPTION

The Voice Alarm Panel allows to give multiple live voice evacuation notices and the issuing of alert and evacuation messages through up to 56 selection memories of PA zones in a NEO system.

FUNCTIONS

1. Up to 56 zone memories with 8 addressing zones per memory (448 zones through expansion keyboards)
2. Volume adjustment
3. Power supply indicator
4. Emergency condition general indicator
5. Fault condition general indicator
6. System link fault indicator
7. Power supply fault indicator
8. Emergency microphone fault indicator
9. Voice evacuation warning indicator
10. Indicator of voice evacuation recorded message emission
11. Indicator of voice alert recorded message emission
12. Remote control indicator
13. Emergency, reset, acknowledge, test, alert message and evacuation message controls

INTEGRATION WITH ACSI V2 PROTOCOL

The new version of the ACSI protocol has been released with firmware v02.04.xx.xx for NEO devices. This version has been integrated into the v02.xx version of the VAP, taking advantage of its enhanced capabilities and new features.

The ACSI v2 protocol brings many improvements over its previous version v1. Some of these, especially those affecting the VAP, include:

- ✓ Support for up to 32 devices on the bus; VAP can only obtain addresses from 1 to 8.
- ✓ Faster linking process.
- ✓ Addition of "groups" functionality, allowing the definition of zone groups that can be used throughout the system.
- ✓ Enhanced customization of zone memories using zone groups.
- ✓ Improved feedback information from the main device to secondary devices, indicating at a zone level where a request has been accepted or rejected.
- ✓ Expanded system status information, including its zones and zone groups.
- ✓ Information when another device is using the bus audio channel.
- ✓ Pre-evaluation function for operations before execution.

ACSI VERSION

The VAP connects to the PAVA system through the ACSI bus (see point 2.3.1). Depending on the configuration of the system, the ACSI bus can work in version 1 or 2. At the physical level both versions are identical, they only differ at the functional and protocol level.

The VAP can work in both ACSiv1 and ACSiv2 versions, maintaining the same functionality, in addition to the improvements explained in the previous point. This will depend on the firmware version installed on your VAP.

Firmware versions v01.xx integrate ACSiv1, and firmware versions v02.xx will work in ACSiv2.

You can easily differentiate which firmware version your VAP has installed by observing the boot sequence of the LEDs in the top row when the device is turned on:

- If a downward power-up sequence is performed, it is a v01.xx microphone ready to connect to ACSiv1 buses.
- If the LEDs flash twice simultaneously on power-up, it is a microphone with firmware v02.xx, intended for connection to ACSiv2 buses.

Important note: be aware that ACSiv1 and ACSiv2 devices cannot be mixed on the same bus. ACSiv1 devices will not operate on buses configured as ACSiv2 or vice versa.

2.1 INDICATORS

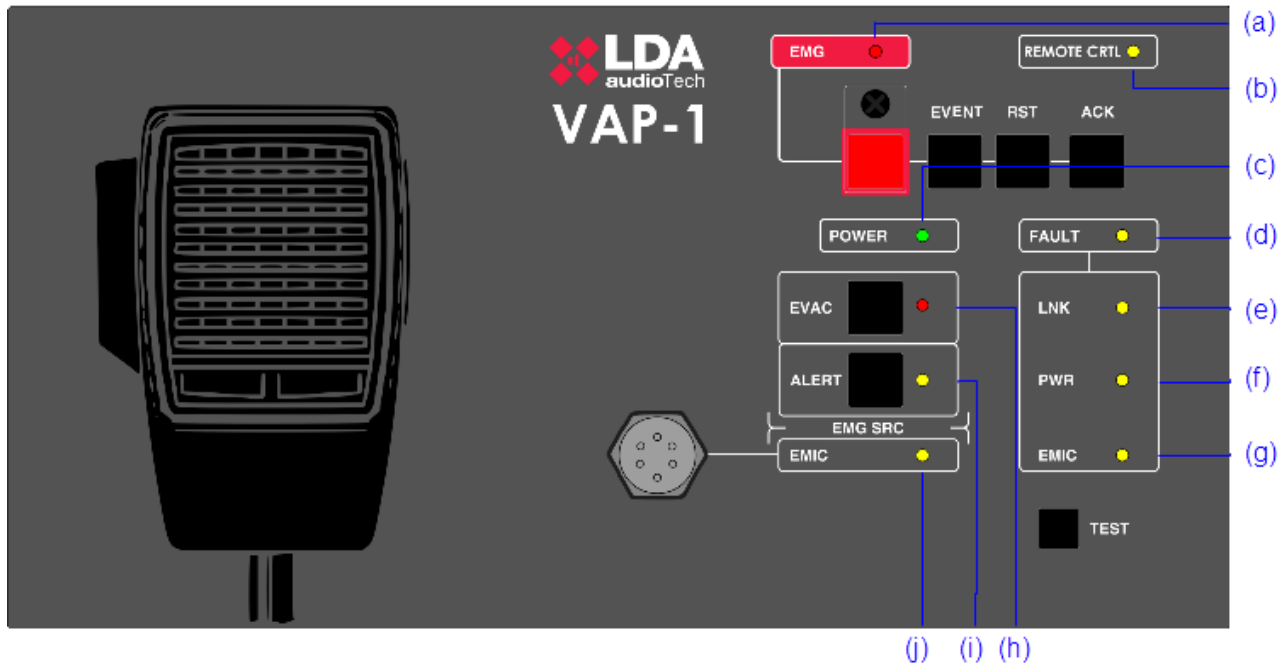

Illustration 1: Indicators

2.1.1 GENERAL CONDITION INDICATORS

Condition indicators show at all times the operating condition of the equipment or system.

(a) EMG: "EMERGENCY"

Active (on) when the equipment is in an emergency operation condition (voice alarm), either by manual or automatic activation from the ECI of any voice alarm zone. When in the emergency condition a warning voice is being issued, whether through emergency microphone or through recorded evacuation message, the indicator will light up intermittently. Red color.

Simultaneously to the indicator lighting, a continuous audible warning will sound. This warning can be silenced with the "ACK" control, or automatically when the emergency microphone is used.

(b) RMT CTRL: "REMOTE CONTROL"

Active (on) when the equipment is remotely controlled from the system controller, or from another VAP 1 with higher priority. This indicator is deactivated automatically when it starts to operate from the VAP 1. Amber color.

(c) POWER: "POWER"

Active (on) when the equipment is powered from any possible power supply. Green color.

(d) FLT: "FAULT"

Active (on) when the equipment is in fault condition. This indicator is activated automatically after detecting a fault of any of the monitored functions. Amber color.

Simultaneously to the indicator lighting, an audible intermittent warning will sound. This notice can be silenced with the "ACK" control or automatically control when the emergency microphone is used.

2.1.2 SUPERVISED FUNCTIONS INDICATORS

Supervised function indicators show the faults that affect the general system functions. These indicators are grouped under the general indicator "FAULT".

(e) LINK: "LINK"

Active (on) when a link fault between the computer and the system occurs. Restart the fault condition. If the problem persists, see section Error: No se encuentra la fuente de referencia for resolution. Amber color.

(f) POWER: "POWER"

Active (on) when a fault in the system occurs. It may be due to a fault in the main power supply, or emergency power supply. Restart the fault condition. If the problem persists, see section 7.5 for resolution. Amber color.

(g) EMIC: "EMERGENCY MICROPHONE"

Active (on) when a fault in the emergency microphone occurs. Restart the fault condition. If the problem persists, see section 7.7 for resolution. Amber color.

2.1.3 EMERGENCY ALERT SOURCE INDICATORS

Emergency alert sources indicators indicate the operating condition of the pre-recorded messages of the system and the emergency microphone.

(h) EVAC: "EVACUATION"

Active (on) when the message that is being issued is intended for the evacuation of the voice alarm zone or zones selected. Red color.

(i) ALERT: "ALERT"

Active (on) when the message that is being issued is intended for the alert of the voice alarm zone or zones selected. Amber color.

(j) EMIC: "EMERGENCY MICROPHONE"

Active (on) when the microphone is available to issue an evacuation message in the zone or zones selected. If the indicator is off, wait for it to turn on, a warning signal might be sounding. Amber color.

2.1.4 SELECTION INDICATORS

Zone extensions for the Voice Alarm Panel feature zone memory selection indicators. When selected by pressing the corresponding key, the indicator next to it activates (on). Green color.

2.2 CONTROLS

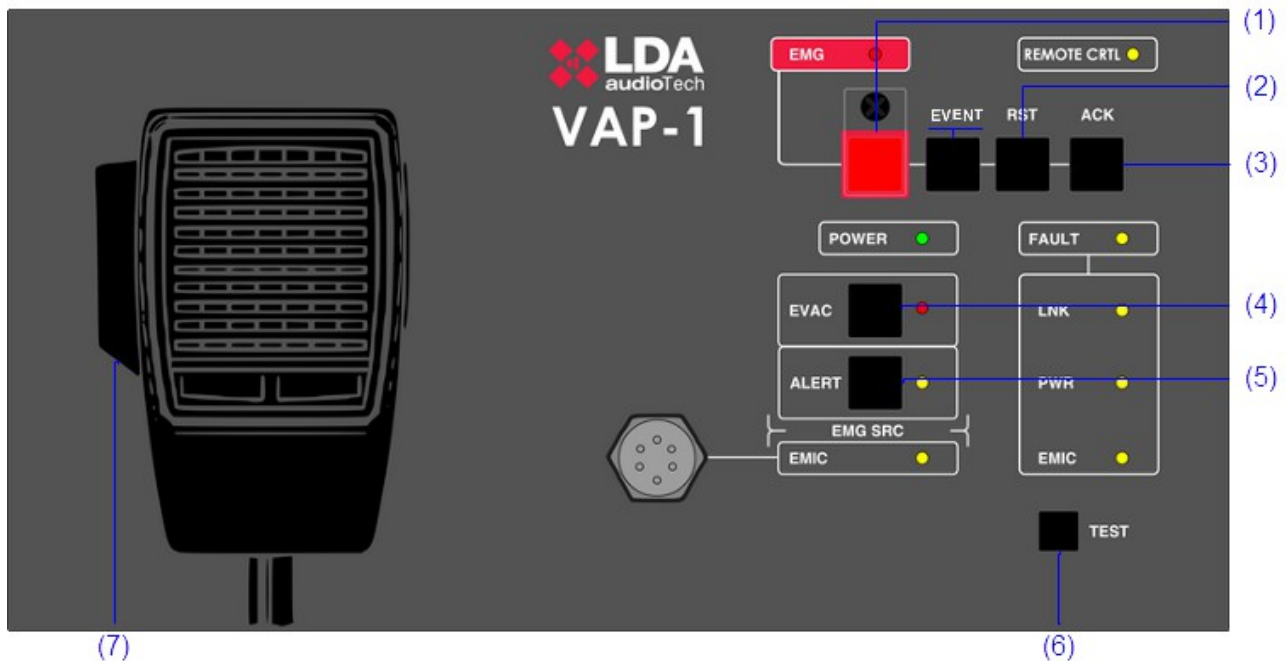

Illustration 2: Controls

2.2.1 EMG

The EMG button, red color, is located in the upper left part of the equipment. It offers protection against accidental pushing. It allows to change the system condition to evacuation mode.

2.2.2 RESET

The "RESET" button is located at the top of the equipment. The "RESET" button restarts the operating condition of the computer, when it is in an emergency or fault condition. It will have to be pressed for 2 seconds.

2.2.3 ACK

The "ACK" button is next to the "RESET" button on the right part of the equipment. It allows to confirm that the indication of an emergency or fault condition has been noticed. By pressing it, the audible emergency or fault warning will be muted.

2.2.4 EVAC MSG

The "EVAC MSG" button is located at the left bottom of the equipment. It allows to issue the evacuation recorded message in all zones of the system, or in those zone memories that are selected, in case of having expansion keyboards.

2.2.5 ALERT MSG

The "ALERT MSG" button is located at the left bottom of the equipment. It allows to issue the alert recorded message in all zones of the system, or in those zone memories that are selected, in case of having expansion keyboards.

2.2.6 TEST

The "TEST" button is located at the left bottom of the equipment. It allows to check the correct operation of all indicators. While the "TEST" button is pressed all of them will light up simultaneously and an audible warning will be issued. When the button is released, the test will end. During the testing process all manual controls will remain inactive.

2.2.7 TALK

It is located on the left side of the hand microphone. It allows to request the voice evacuation warning channel in every zone of the system, or in the zone memories that are selected in case of having expansion keyboards.

The "EVENT" button (only available in S02 version) allows events launching. See 3.2.5

2.2.8 ACSI BUS TERMINATOR

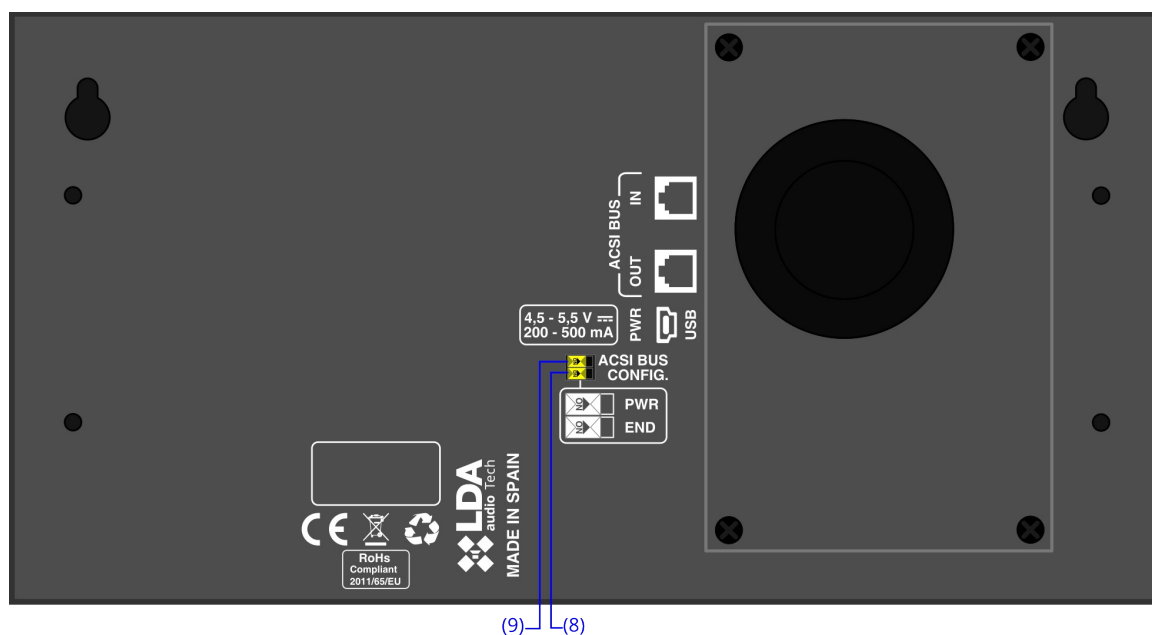

Illustration 3: ACSI BUS selectors

The terminator selector "EOL" is located in the middle of the rear part of the equipment. It allows the activation/deactivation of the bus terminator. This control must be active when the equipment occupies the last position in the ACSI bus.

2.2.9 ACSI POWER SUPPLY SELECTOR

The equipment has a selector that allows to choose the origin of the power supply, between local and provided through the ACSI bus. When the selector is in 5V position, the equipment will be locally supplied by the external charger provided with the equipment. In this mode, in case of a supply problem through the charger, the equipment will be automatically supplied from the ACSI bus directly. If the selector is in the 24V position, the VAP 1 will be supplied exclusively from the ACSI bus.

2.2.10 KEYBOARD IDENTIFICATOR

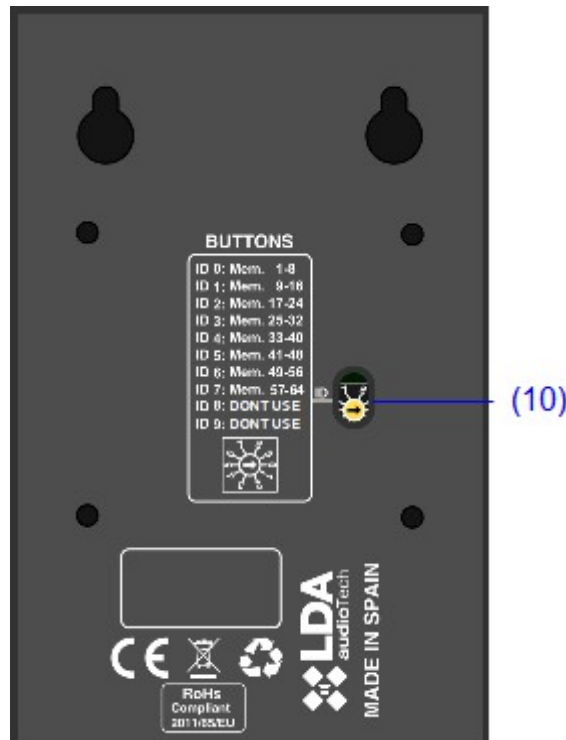

Illustration 4: Keyboard identifier

The keyboard identifier is only available in expansion keyboards attached to the VAP 1. "ID" is located in the middle of the base of the equipment. It allows to choose the position of the expansion keyboard in the set. Each keyboard must have a unique identifier. In a system where zone memory keys have not been configured, the zone that each expansion keyboard will take is determined by the selected identifier. So we have:

- ID 0: Memories 1-8
- ID 1: Memories 9-16
- ID 2: Memories 17-24
- ID 3: Memories 25-32
- ID 4: Memories 33-40
- ID 5: Memories 41-48
- ID 6: Memories 49-56
- ID 7: Memories 57-64
- ID 8: Position not allowed
- ID 9: Position not allowed

2.3 INPUTS AND OUTPUTS

To access the inputs and outputs of the equipment and make the connections, remove the four M3 screws that attach the cover to the rear part of the equipment. The cover has a rubber membrane that can be perforated to allow the cables or tube to get through.

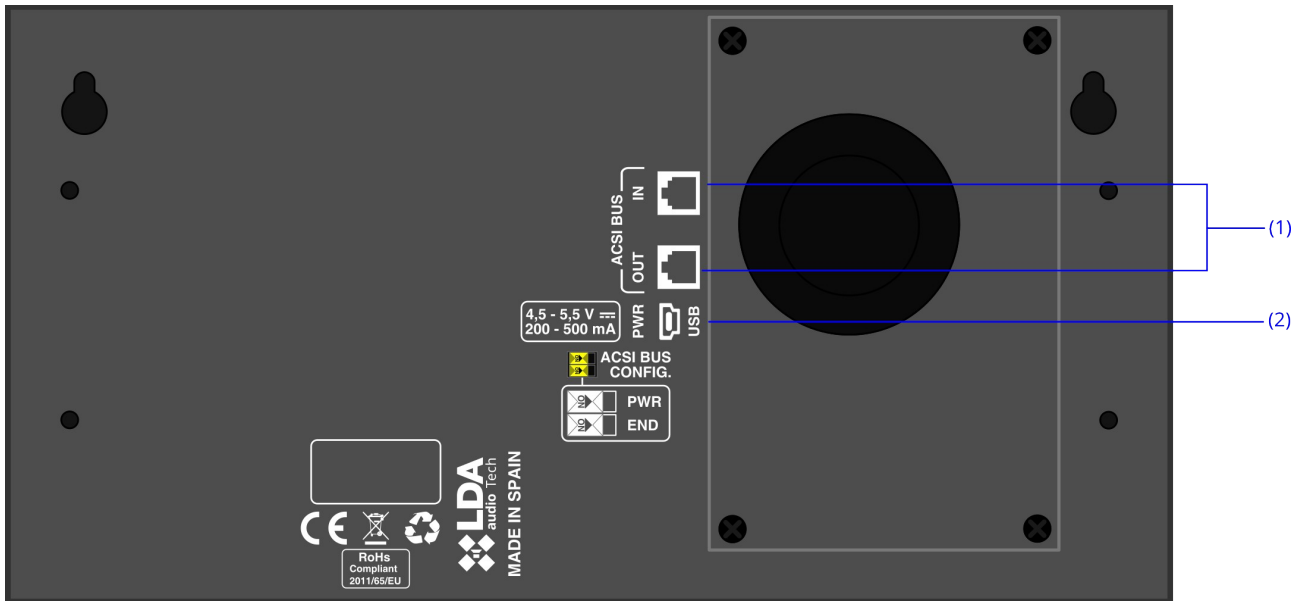

Illustration 5: Inputs and outputs

2.3.1 PA SYSTEM INPUT/OUTPUT

The equipment has two connections for distributed elements in Public Address Systems. It consists of a line level audio input plus control signals for connecting up to 8 devices in bus mode "daisy chain", where each device is connected to the next. Both connections are identical and are interconnected. The ACSI bus supplies remote power to the equipment, see 2.2.8.

The connection is via ethernet cable, T568B standard. The maximum distance of connection for the entire bus is 1000m (3280ft).

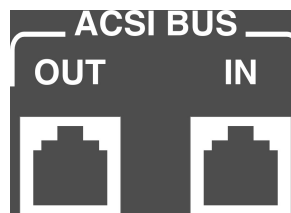

Illustration 6: ACSI Bus Connection

Mark	Description	Type	Signals	Activation
BUS ACSI	Line level balanced audio Control bus and supply	I/O	Protocol	N/A

Table 1: ACSI Bus Connection

NOTE: This connection is not compatible with standard ethernet electronic.

2.3.2 EXTERNAL POWER SUPPLY/UPDATE INPUT

The unit has an input for auxiliary power supply. Emergency stress is continuous and has a nominal value of 5V that will be externally supplied to the computer using a USB charger provided with the machine. MiniUSB female connector.



*Illustration 7:
Supply/Update
input*

Mark	Description	Type	Signals	Activation
PWR USB	External supply input	Port	USB 1.1	4,5 – 5,5V DC Current: 200 – 500 mA

Table 2: External supply input

The connection is made with a miniUSB A male cable (provided with the equipment).

2.3.3 PORTS FOR EXPANSION KEYBOARDS

The equipment has a port on the right side of the unit for connecting additional keyboards.

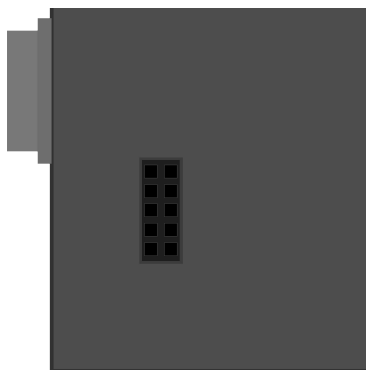

Illustration 8: Expansion Port

Mark	Description	Type	Signals	Activation
	Expansion port	I/O	-	N/A

Table 3: Expansion port

3 OPERATION DESCRIPTION:

3.1 TURNING ON

Select the origin of the power supply of the equipment according to 4.1. Connect the power cord to the connector "POWER" on the rear part of the equipment or power it directly from the ACSI bus. An indicator checking sequence will appear in the front part of the equipment. Once the sequence is concluded, the linking process with the system will start and it will be indicated by the corresponding indicator (LNK).

When the equipment is turned on for the first time, typical adjustments of the installation must be done (see section 4.2)

3.2 EMERGENCY

3.2.1 ACTIVATING EMERGENCY CONDITION

To give an evacuation notice, the system must be in an emergency condition. This mode of operation will be able to issue the following notices types:

- Recorded alert message
- Recorded evacuation message
- Live message from emergency microphone

To activate the emergency mode, proceed as follows:

Remove the protective cover of the "EMG" button and push the button. If the equipment has priority to activate the emergency condition, the "EMG" indicator will light up.

When the emergency condition is activated, an audible warning signal will be activated. This signal will be automatically muted when using the emergency microphone or manually by pushing the "ACK" key.

3.2.2 ISSUING VOICE WARNING

Once the emergency condition is activated, you will be able to select the following options to make a voice warning:

- Issuing a recorded warning message: "ALERT"
- Issuing a recorded evacuation message: "EVAC"
- Issuing a live message from the microphone: "EMIC"

To issue a voice warning, if you have an expansion keyboard, select the zone memories where you want to deliver the notice, their selection indicators will light up. In case you do not have expansion keyboards, or have not made any selection, all the zone memories will be selected automatically. Then press the "EVAC", "ALERT" or "TALK" button to issue recorded evacuation, alert, or live messages respectively.

Simultaneously, it can issue a recorded message and a live message through the same or different selection than the currently issue message. The priority of emergency sources from highest to lowest is: Live message from emergency microphone, Recorded evacuation message, Alert recorded message. From the front panel of the VAP, you can switch between the desired message type by first selecting a set of zones or a single zone and pressing the corresponding message.

If you want to evacuate or alert a different set of zones and the alert or evacuation is already active, you must first deactivate the corresponding message and then press the type of alert you want to issue again.

Note: The previous zone memories selection will disappear when you make a new selection.

3.2.3 STOPPING VOICE WARNING

To stop the issuance of a warning voice, in case it is a recorded message, push the button of the message that you want to stop. To stop the live voice warning release the "Talk" button on the microphone.

You can also stop issuing the condition by deactivating the emergency condition (see 3.2.4)

3.2.4 DEACTIVATING EMERGENCY CONDITIONS

If you want to deactivate the emergency state, press the "RESET" key for 3 seconds, and the EMG LED will start flashing.

If the system accepts the request, all emergency warning will be stopped. If the system denies the request, the REMOTE CTRL LED will light up.

3.2.5 EVENT LAUNCHING

You can launch events that have been configured in the NEO system. In order to do this, extension panels for event launching should be previously installed.

How to use programmed events:

To launch an event, push the EVENT button. The keyboards' leds flash for a few seconds to indicate that you have to select the appropriate button. Then the pushed button's led flashes in green, pointing out that the order has been processed. If it can't be processed, the REMOTE led will flash, indicating that it's not possible to execute it.

For you to be able to stop the launched events, it's recommended to create an output condition trigger and associate it to an unassigned button.

3.3 FAULT

3.3.1 MUTING FAULT CONDITION

If you want to silence the audible fault indicator, press the "ACK" button. The audible indicator will also be automatically muted when you press the "TALK" button on the emergency microphone.

3.3.2 RESETTING FAULT CONDITION

To reset the fault condition press the "RESET" key for 2 seconds, the equipment will restart the fault condition. If the fault condition persists, it will be indicated again.

3.4 TESTING

To perform a test of the equipment indicators, press and hold the "TEST" key. All indicators will light up simultaneously, and the audible indicator will sound. To stop the test, release the "TEST" key.

If the system is in emergency mode, the TEST mode is disabled.

3.5 FACTORY RESET

To perform a general reset of the equipment, simultaneously press the "ACK," "RST," and "TEST" keys for 5 seconds. The equipment will restart.

The equipment will lose its configuration, so it will need to be reconfigured.

3.6 POWER-SAVING MODE

The VAP device includes a low-power mode to reduce power consumption. When the system is in emergency mode and has not been manipulated for 60 seconds, the LEDs on the expanders will turn off, erasing their previous selection. You will need to reselect the desired zones to send the desired message or speak again.

3.7 ZONE MEMORY SELECTION

Before broadcasting an announcement, you can activate each of the zone memory selection controls to choose over which zone or zones the message will be broadcast. By default, these memories will be assigned directly to the zones of the system, so Memory 1 will select Zone 1, Memory 2 will select Zone 2, and so on. This assignment can be customized through the configuration of the public address system to which your VAP is connected. Each selection memory can be assigned to a specific zone or a group of zones. The number of available zones and groups depends on the features of the public address system. For example, NEO and NEO+ systems offer up to 64 configurable zone groups with high flexibility. It's also possible to create groups that call all system zones from a single memory button.

Those zone selection memories that have no assignment or an invalid assignment will remain disabled. When their button is pressed, the indicator light will flash rapidly for a moment and then turn off, indicating to the user that this zone selection memory is not available due to the lack of an associated configuration.

4 CONNECTION AND SETTING UP

The VAP 1 is supplied with an external power source with a DC 5V USB A female which is connected via a miniUSB AB male cord to a USB A male, also provided with the equipment (see 2.2.9). To supply the equipment, you can use it or supply it directly from the ACSI bus, through its connection to the bus. If this is the case, keep the power supply for later use.

4.1 SUPPLY

The VAP 1 is supplied with an external power source with a DC 5V USB A female which is connected via a miniUSB AB male cord to a USB A male, also provided with the equipment (see 2.2.9). To supply the equipment, you can use it or supply it directly from the ACSI bus, through its connection to the bus. If this is the case, keep the power supply for later use.

4.2 CONNECTION TO THE SYSTEM OF VOICE EVACUATION (ACSI BUS)

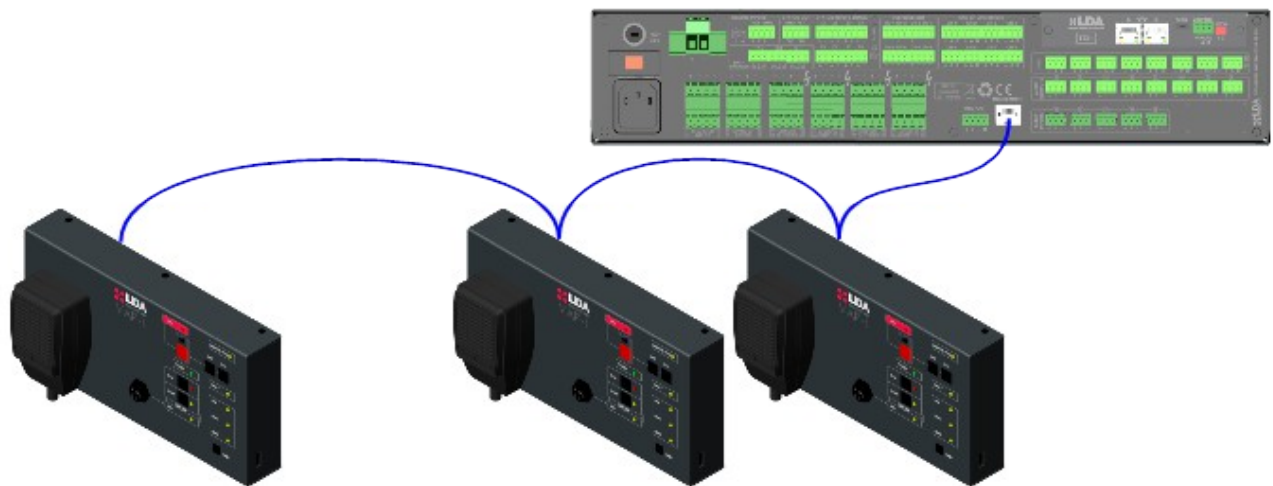

Illustration 9: Connection to the system of voice evacuation

The equipment has two connections to connect to the voice evacuation system. The connection for all the elements is in bus mode. Each device is connected to the previous one, up to eight devices and a maximum total wiring of 1000m (914.4 yd).

4.3 ADDRESSING AND PRIORITY CONFIGURATION

Each device must have a unique address within the bus, up to a maximum of 8 devices. Two or more devices cannot share the same address, as this could lead to addressing conflicts within the bus.

In ACSI v1 devices, the address will coincide with the word priority within the bus. Depending on the configured priority, it will be allowed to occupy the channel when it is already in use by another device, with the lowest number having the highest priority.

ACSI v2 devices have configurable priority through the system configurator, regardless of their address. By default, all ACSI v2 devices have the same priority, implying that they cannot occupy the bus if it is already in use by another user.

To set the direction ACSI VAP 1, proceed as follows:

- Make sure the computer is not in a condition of emergency. The "EMG" indicator will be off.
- Hold the "RESET" button and the "ACK" button for at least 3 seconds.
- The access to the address setting will be confirmed with the intermittent lighting of the "REMOTE CTRL" and "EMG" indicators. The configured bus address will be indicated with the lighting of the fault and "EMIC" indicators as shown in the table 4:

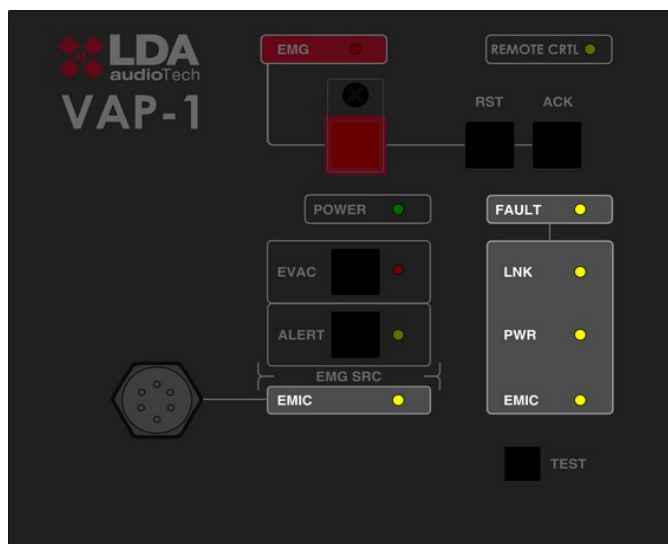

Illustration 10: ACSI Bus Address Signal

ADDRESS	INDICATOR		FAULT INDICATORS		
	EMIC	FAULT	LNK	PWR	EMIC
1	OFF	OFF	OFF	OFF	ON
2	OFF	OFF	OFF	ON	OFF
3	OFF	OFF	ON	OFF	OFF
4	OFF	ON	OFF	OFF	OFF
5	ON	OFF	OFF	OFF	ON
6	ON	OFF	OFF	ON	OFF
7	ON	OFF	ON	OFF	OFF
8	ON	ON	OFF	OFF	OFF

Table 4: ACSI Bus Address Signal

- Push the recorded message "EVAC" and "ALERT" buttons to increase or decrease the equipment address. With each tap the new address will be shown in the indicators, as shown in the table 4.
- Push the "ACK" button to confirm, "RST" to cancel the address change.
- The computer will restart with the new bus address.

If when starting the VAP 1, "REMOTE CTRL" and "EMG" indicators light up simultaneously, there is an address conflict with this device in the ACSI bus. In that case you must change the address.

4.4 VAP 1 CONFIGURATION

The VAP 1 allows to set different operating parameters. To access the configuration of the equipment proceed as follows:

4.4.1 CONFIGURATION. WARNING TONE

To access the warning tone configuration, proceed as follows:

- Make sure the computer is not in a condition of emergency. The "EMG" indicator will be off.
- Push and hold the "ALERT" and "EVAC" buttons for at least 3 seconds.
- Access to the configuration is confirmed when the "POWER" button lights up
- If the function is activated, the "EMIC" indicator will remain on.
- To activate or deactivate the warning tone, press the "TEST" button. Each tap will indicate whether the tone is active by activating or deactivating the "EMIC" indicator.
- Push the "ACK" button to confirm; "RST" to cancel the change.

4.4.2 CONFIGURATION. OUTPUT VOLUME

To access the output volume setting, proceed as follows:

- Make sure the equipment is not in a condition of emergency. The "EMG" indicator will be off.
- Push and hold the "ALERT" button and "EVAC" button for at least 3 seconds
- The access to the configuration will be confirmed by the blinking light up of the "POWER" indicator.
- Push the "EVAC" button to increase the volume and the "ALERT" button to decrease the output volume. Each tap will be accompanied by the lighting up of the associated indicator as confirmation. When the maximum or minimum volume is reached, the "EVAC" or "ALERT" indicators will remain on.
- Press the "ACK" button to confirm; "RST" to cancel the change.

4.5 EXPANSION KEYBOARDS CONNECTION

The VAP 1 can equip up to 7 expansion keyboards with 8 zone memories each one. To connect the expansion keyboards, it features a port on the side that allows the installation on the right side of the main unit.

To install, proceed as follows:

- Disconnect the VAP 1 from the bus and its power supply, whether it is supplied from the ACSI bus or locally (see chapter 4.1)
- Place the adapter (supplied with the expansion keyboard) on the side port and match the sides of both equipments until the electrical connection is complete. Illustrations 11, 12 y 13
- Turn over both equipments together and screw the connecting metal piece that blocks the bodies of both equipments (provided). illustration 14.
- Set the expansion keyboard ID as described in section Error: No se encuentra la fuente de referencia.
- Reconnect the VAP 1 to the system. By default, the new keys will take the zones of the system as described in section Error: No se encuentra la fuente de referencia.

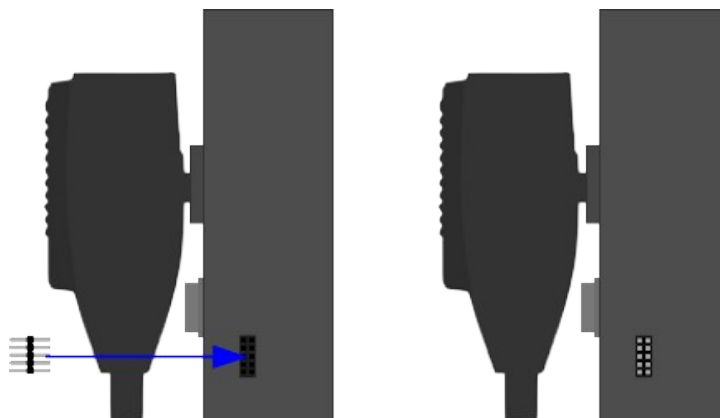

Illustration 11: Expansion Keyboard Connection. Step 1 Adaptor

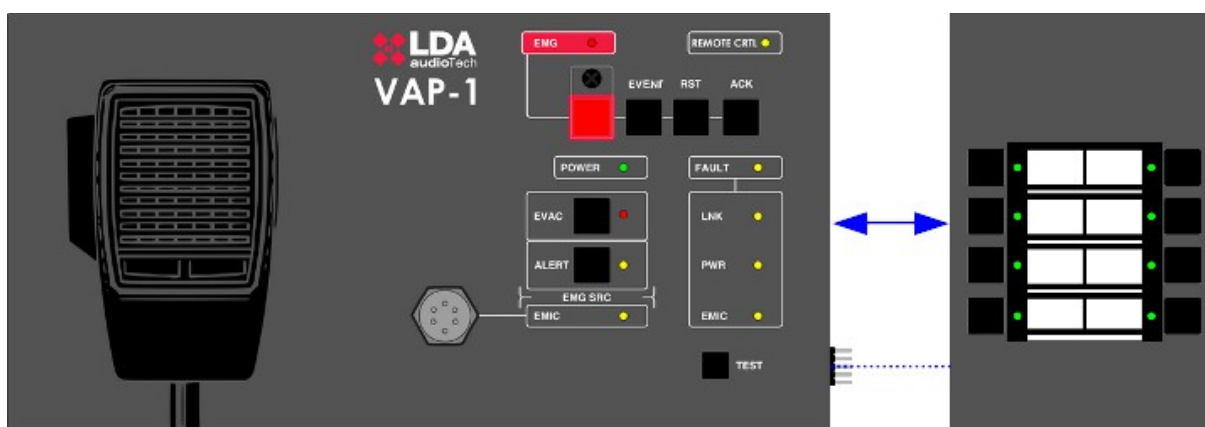

Illustration 12: Expansion Keyboard Connection. Step 2

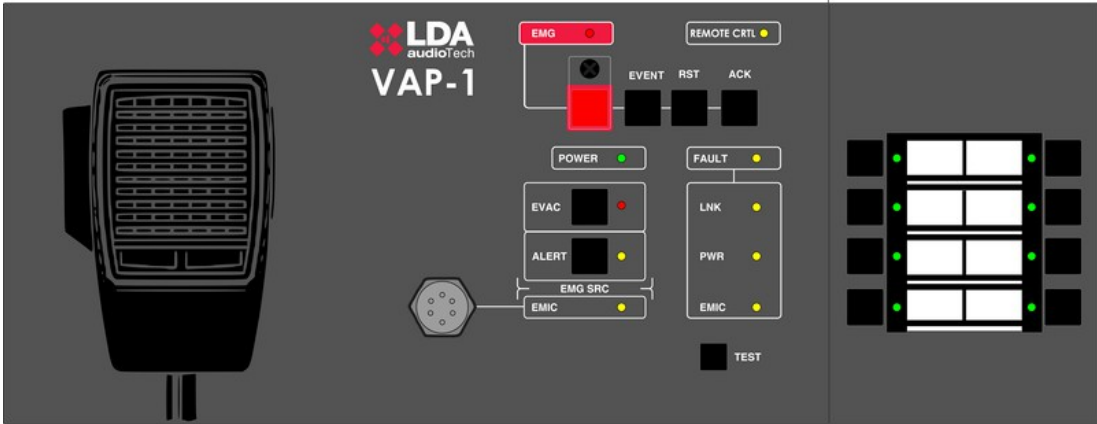

Illustration 13: Expansion Keyboard Connection. Step 3

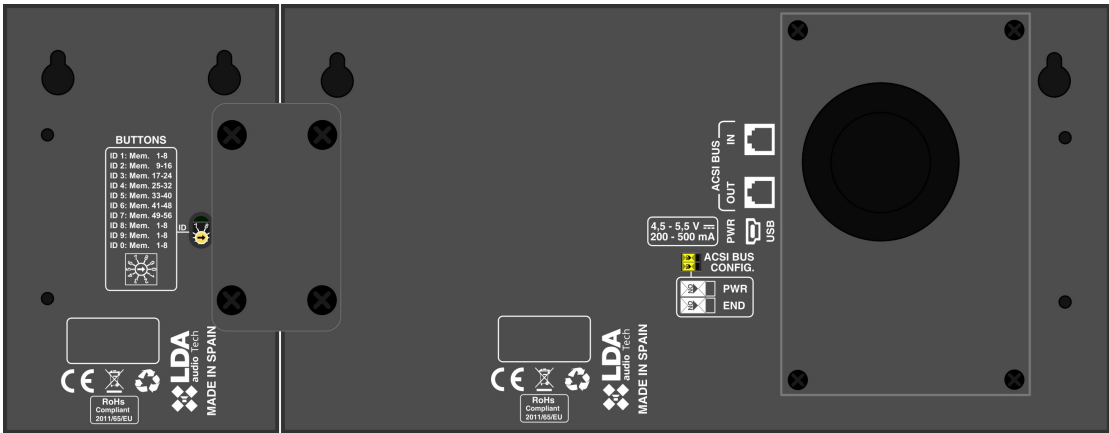

Illustration 14: Expansion Keyboard Connection. Step 4 Block

When connecting keyboards for a set to be mounted in a rack (see section 6.1), the connection between the last keyboard of the first row, and the last keyboard of the second must be done with the connection ribbon cable provided with the equipment. In that case, the configuration of the expansion keyboards address (see section 4.5) can be done as shown in Illustration 15, where you can see where the ribbon cable must be placed. To make this connection, the whole set even the mounting accessories must be mounted.

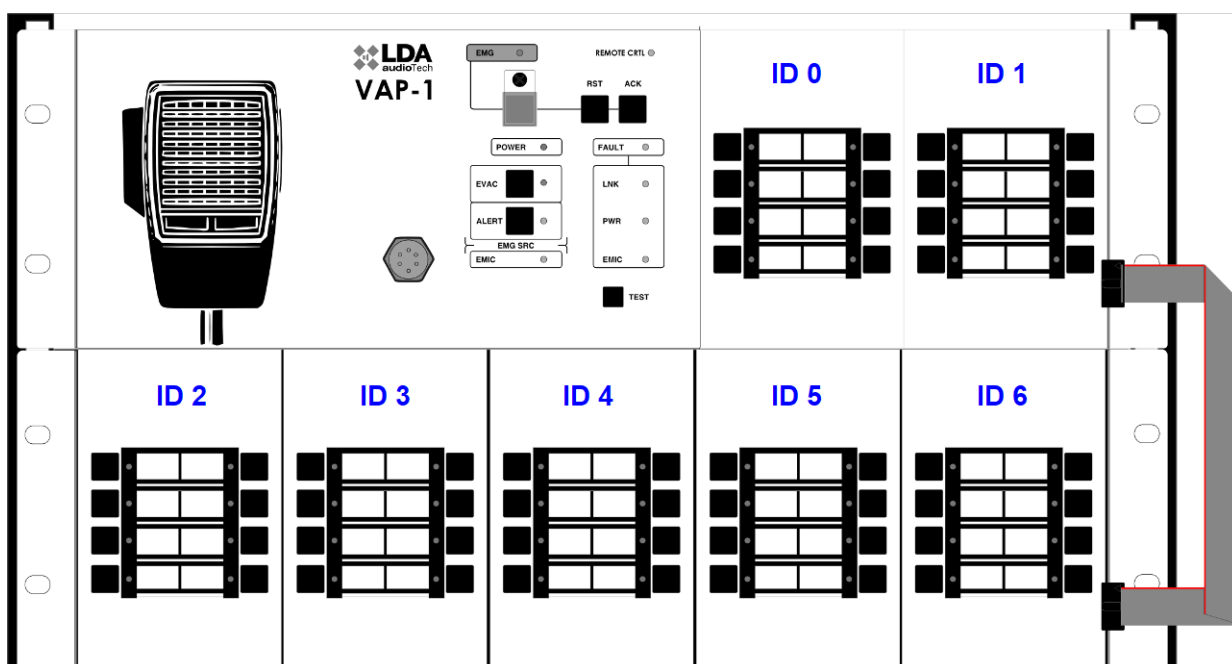

Illustration 15: Expansion Keyboard Connection. Rack mounting

4.6 BUSY BUS INDICATION

The new ACSI v2 version incorporates a busy bus indicator. This will be indicated by a slight flashing of the REMOTE CTRL indicator when another microphone is currently occupying the bus.

Regardless of this indication, the user can make a call if desired, but the outcome depends on the priority configured in the system for their VAP: the turn will be granted to the VAP with the highest priority. If all devices are configured with the same priority, conversation exclusion will never occur.

This indicator allows the user to avoid interrupting the message of a less prioritized device and wait to make their call when the bus becomes inactive again.

4.7 ACSI BUS VERSION ERROR DETECTION

ACSI v1 and ACSI v2 versions are not compatible and cannot operate together on the same bus. The main system device, such as NEO8060, must be configured to operate in one of these modes.

If a ACSI v2 VAP is connected to an ACSI v1 bus, the equipment can detect ACSI v1 traffic and alert the user of the incorrect bus configuration.

This error will be indicated by the alternating flashing of the "EMG" and "REMOTE CTRL" LEDs.

5 UPDATE

If an equipment Firmware update is required, make sure that the update image provided matches your model. If the equipment has expansion keyboards connected it is not necessary to disconnect them.

The update is performed from the NEO System Configuration Software. In the device view it will be possible to send a firmware update.

The update process is automatically made from the NEO equipment to the ACSI devices. This may take a few minutes depending on the device and the system. During this time the device will not be operational.

6 INSTALLATION

6.1 INSTALLATION FOR THE 19" RACK

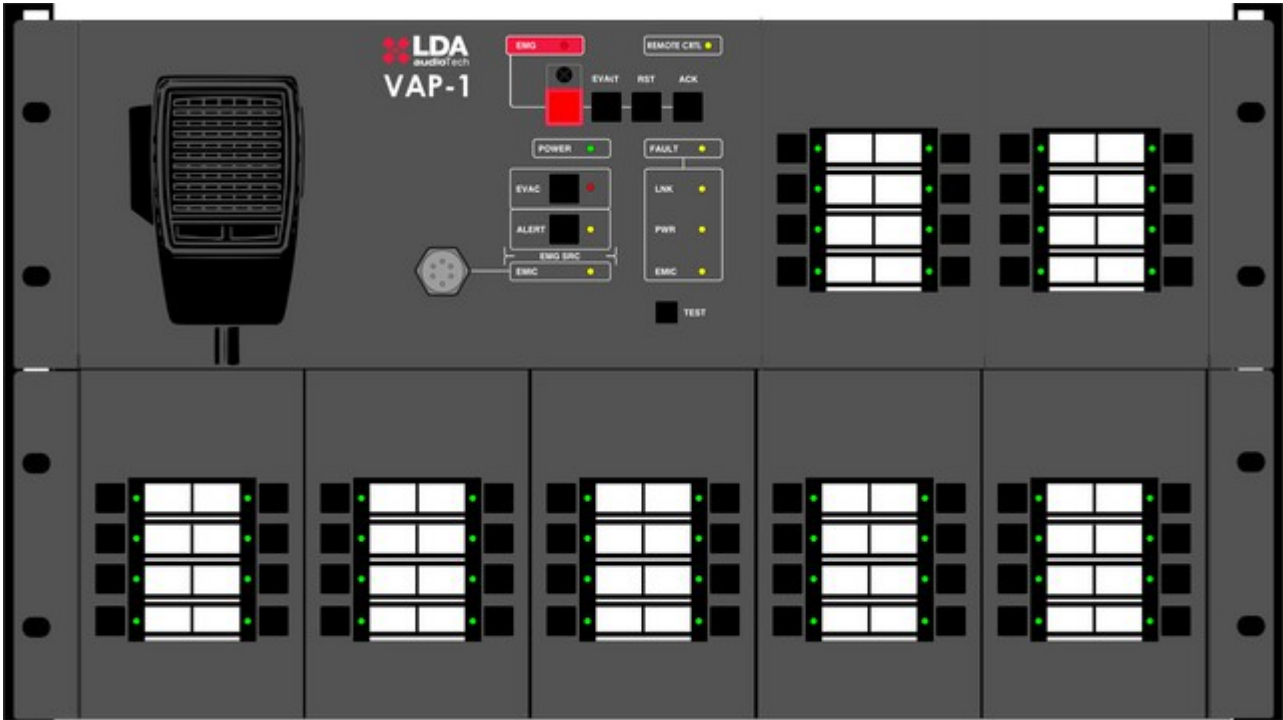

Illustration 16: Rack installation

The VAP 1 is provided with accessories for its installation in a 19" rack that must be attached to the rear part of the equipment with 4 M4 screws. To adjust the width of the equipment, you can use expansion keyboards or rack complements. The following are the different combinations of installation, where the keyboards shown can be replaced by rack complements

6.2 WALL INSTALLATION

The VAP 1 has two openings at the rear part for wall mounting with self-tapping screws, whose heads have a maximum diameter of 9 mm and 4 mm wide shank.

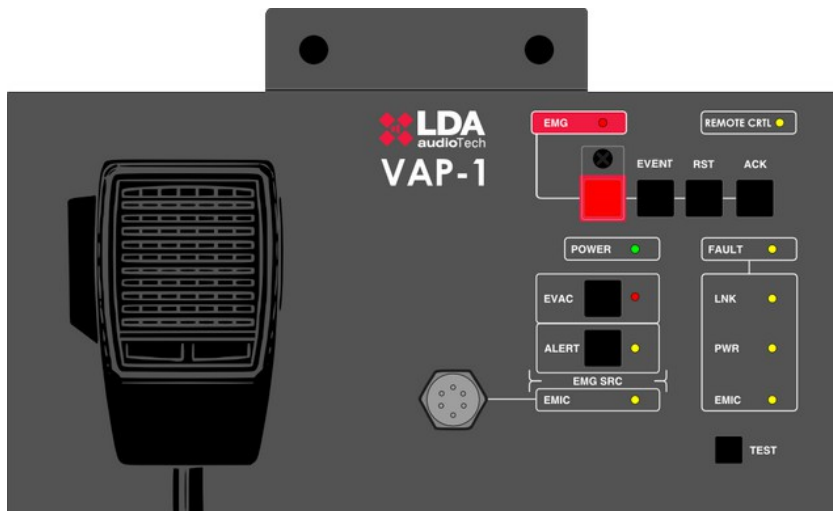

Illustration 17: Wall installation

To install it, drill two holes on the surface where the equipment will be located. The holes must follow the measures specified in illustration 18, where distances between holes in a VAP 1 with two expansion keyboards are shown. When mounting it is only necessary to use the openings on the end of the set. Once the equipment is placed properly lock at the top using the accessory provided.

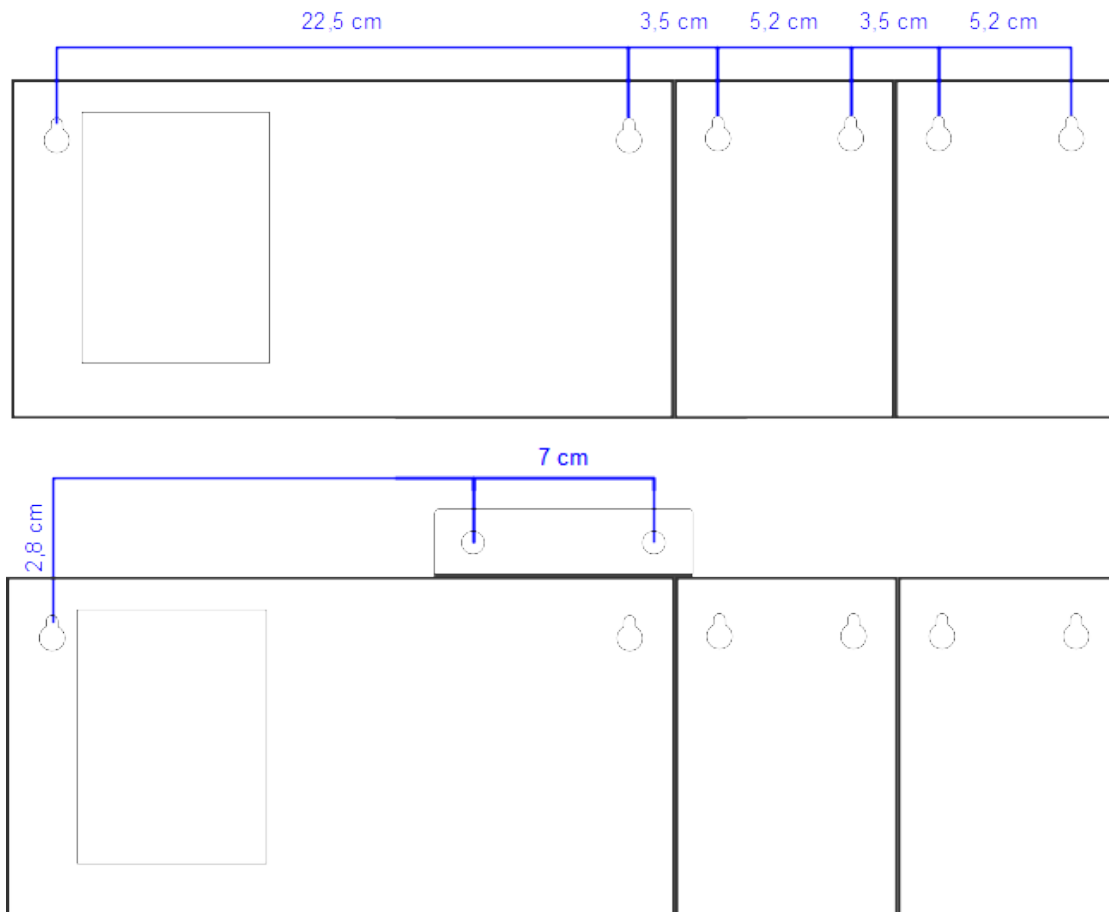

Illustration 18: Wall installation template

7 FAULT RESOLUTIONS

7.1 ERROR CODES

When any error is shown on the VAP-1, as it has not zones included (just VAP extensions) the LED corresponding to the failure will light-up.

I.E:

If there is link failure: That led is lit and the VAP get blocked.

If there is PTT failure: EMIC LED lits and the VAP get blocked.

Etc.

7.2 THERE IS NO LINK WITH THE SYSTEM

The equipment will indicate a link failure with the system when it detects that the transmission path is shorted or disconnected.

Check that the VAP 1 that does not link is the only bus that can not connect. If there are more equipments in the bus with this problem, start by checking the closest to the equipment where the bus (NEO) begins.

Check that the equipment to which the ACSI bus (NEO Controller) is connected works properly.

Check that the last bus equipment has the "Bus Terminator" option on, according to section 2.2.8

Connect the auxiliary power supply provided with the equipment, in case the VAP 1 is directly supplied from the ACSI bus

Make sure the connection between the equipment and the system has been carried out correctly according to section 4.2. To debug the fault, disconnect both ends of the two bus cables connected between the system and the equipment, and measure between each of the cable terminals with a multimeter on the scale k Ω . If the measurement result is 0, the line is short-circuited, and should be checked or replaced. If the result is 1, it means that it is correct.

Do a RESET (the equipment will have to be reconfigured). To do so, push simultaneously the "ACK", "RST" and "TEST" keys for 5 seconds. The equipment will restart. Set the equipment address according to 4.2

If none of the above works, remove the equipment from the bus and contact the support/repair service. If there are more equipments connected to the bus, connect the input and output lines of the ACSI bus of the equipment so that the rest of the system keeps working normally.

7.3 "REMOTE CTRL" AND "EMG" INDICATORS BLINK SIMULTANEOUSLY

The system will indicate an ACSI bus address fault when two equipments have the same address.

Check that the bus address is correct, for this follow the steps in section 4.2

Do a RESET (the equipment will have to be reconfigured). To do so, push simultaneously the "ACK", "RST" and "TEST" keys for 5 seconds. The equipment will restart. Set the equipment address according to 4.2

If none of the above works, remove the equipment from the bus and contact the support/repair service. If there are more equipments connected to the bus, connect the input and output lines of the ACSI bus of the equipment so that the rest of the system keeps working normally.

7.4 “REMOTE CTRL” AND “EMG” INDICATORS BLINK ALTERNATIVELY

The system will indicate that the ACSI bus is configured with an incorrect version. ACSI v2 is not compatible with its previous version, ACSI v1, so devices with different ACSI bus versions cannot operate together. The bus must be correctly configured in the public address system. See section 4.

7.5 NO INDICATOR LIGHTS UP

If this is the case, there is probably a problem with the power supply of the equipment.

If the equipment is supplied from the ACSI bus, disconnect the equipment from the bus, and connect the auxiliary power supply provided with the equipment. The equipment must perform the indicators verification test.

If the problem persists, or it is connected to the auxiliary power supply and the bus simultaneously, follow the steps in section 4.

7.6 THE VOICE WARNING SOUNDS LOUD/LOW

If the problem is common to all the equipments connected to the bus, check the settings concerning the ACSI bus of the equipment to which the bus (NEO) is connected.

If it is a VAP 1 in particular, check the volume set according to section 4.4.2.

If the warning voice that sounds loud/low is the live message (emergency microphone), and the "EMIC" fault indicator is on, follow the steps in section 7.7. If the indicator is not on, turn on the call warning tone as described in section 4.4.1. Make a call and make sure the tone is heard correctly. If the warning tone is heard, follow the steps in 7.7 or do a RESET (the equipment will have to be reconfigured). To do so, push simultaneously the "ACK", "RST" and "TEST" keys for 5 seconds. The equipment will restart. Set the equipment address according to 4.2

If none of the above works, or the failure affects to both live and recorded messages, remove the equipment bus and contact the support/repair service. If there are more equipments connected to the bus, connect the input and output lines of the ACSI bus of the equipment so that the rest of the system keeps working normally.

7.7 MICROPHONE FAULT

If the "EMIC" Microphone fault indicator remains on, check that the emergency microphone is properly connected to the VAP 1. To do so, unscrew the lock ring, disconnect and reconnect it, and push the "RST" button.

If after reconnecting it turns on again, do a RESET (the equipment will have to be reconfigured). To do so, push simultaneously the "ACK", "RST" and "TEST" keys for 5 seconds. The equipment will restart. Set the equipment address according 4.2.

If none of the above works, contact the support/repair service. Press the "ACK" button to silence the audible warning. The other functions of the VAP 1 as recorded messages broadcasting will not be affected.

7.8 EXPANSION KEYBOARDS DO NOT ADDRESS THE ZONES

If when pressing a zone memory some zone memory indicators light up in different keyboards, the identifier of one of them is not correct or coincides with another expansion keyboard. Check the identifiers according to section Error: No se encuentra la fuente de referencia.

If the problem is not solved, check the connection between the VAP 1 and the expansion keyboards as indicated in section 4.5.

If none of the above has solved the problem, do a RESET (the equipment will have to be reconfigured). To do so, push simultaneously the "ACK", "RST" and "TEST" keys for 5 seconds. The equipment will restart. Set the equipment address according 4.2.

In case that the expansion keyboard does not work yet, disconnect it from the VAP 1 and contact the support /repair service.

7.9 THE EXPANSION KEYBOARD DOES NOT LIGHT UP

If when pressing a zone memory of one or some expansion keyboards the indicators do not light up, one of the expansion keyboards might be damaged.

Check the connection between the VAP 1 and the expansion keyboards as described in section 4.5

If the problem is not solved, disconnect the equipment power supply for a few minutes and check the keyboards from the last to the first one. Disconnect the first expansion keyboard that does not light up and attach the rest to the VAP 1. If necessary, reconfigure the address according to Error: No se encuentra la fuente de referencia and the content of the zone memories with the system configuration application and contact the support/repair service.

8 MAINTENANCE INSTRUCTIONS

The equipment requires a reduced periodical maintenance.

The periodicity of the maintenance must be adjusted in function of the condition of installation of the equipment. It is advisable to establish a maximum period of time of one year.

Warnings:

- Use only a soft lint-free cloth
- Disconnect the equipment from any external power source.
- Disconnect all external devices.
- Keep away from liquids
- Do not use aerosol sprays, solvents, or abrasives.
- Do not spray cleaner directly on the device

Operations:

- Wipe with a damp cloth
- Clean the air inputs and outputs with a vacuum cleaner.
- Check the connections of the equipment.

9 TECHNICAL FEATURES

Model	LDAVAP1
Power Supply	5V DC, 1 x miniUSB AB
Power Consumption	200 - 500 mA (max with all expansion keyboards)
Expansion Keyboard Consumption	40 mA max
Frequency Response	200 Hz – 12000 Hz (+/- 2dB)
Signal to noise ratio	>98dB, A-weighted
Sensitivity	-43 dB (1KHz)
Directionality	Axial, with hypercardioid type polar diagram
Type of transducer	Dynamic with moving coil
DSP	Integrated. 48 kHz, 24 bits – 172 MIPS
ACSI Bus	2 x Identical ACSI ports: Balanced audio 1Vp, 0,707Vrms. 10 KΩ, female RJ-45, Total 1000m. / 3280ft
Expansion Port	1 x Pin row, 2 rows x 5 female contacts
Indicators	Condition: Emergency, General Fault, Remote Control Fault: Link, Supply, Emergency microphone Mensaje in broadcast: Evacuación recorded, Warning recorded, live message
Buttons	Emergency, Reset, Confirmation, (EMG, RST, ACK) 1 button for talking (TALK) Recorded message: Evacuation and Warning Indicators test
Functions	Prior notice tone, volume control, DSA (Dynamic sound adjuster). Directionality until 448 system zones.
Microphone cable length	500mm / 13,75"
Dimensions without microphone (A x H x P)	259mm x 132mm x 50mm / 3,38" x 2,56" x 7,48"
Dimensions with microphone (A x H x P)	259mm x 132mm x 93mm / 3,38" x 2,56" x 7,48"
Keyboard/Rack complements dimensions (A x H x P)	86mm x 132mm x 42mm / 3,38" x 2,56" x 7,48"
Operating conditions	-5 °C to +45 °C / 23 °F to 113 °F 5% to 95% Relative Humidity (no condensation)
Finish	Fe, Grey RAL 7016
Weight	1 Kg / 2,2 lb
Expansion keyboard weight	0,5 Kg / 1,1 lb
VAP 1 accesories	1 x miniUSB AB male to USB A male 1x Power Supply USB connector Type C (EU Type) 1 x Ethernet cable 2m / 6,56ft. 2 x accesories for rack installation 1 x block accessory for wall instalation
Expansion keyboard accesories	1 x expansion port adaptor 2 x 5 contacts male-male 1 x connecting piece to VAP 1 4 x countersunk screw (4 x 8 mm)

